

# Stelar

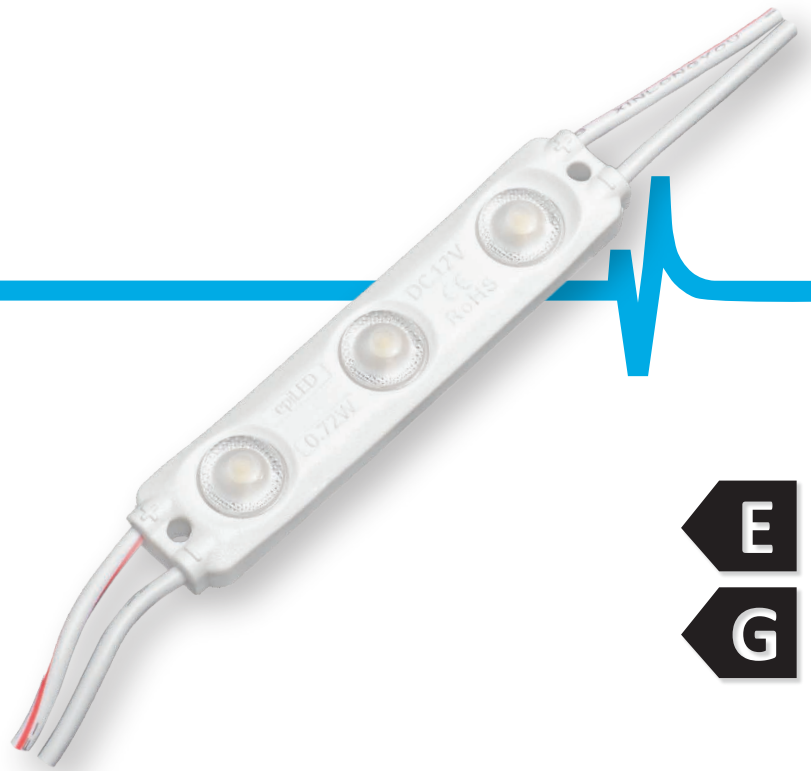

5-15 cm  
channel letters / lightboxes

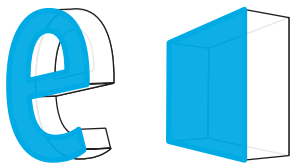

12V  
DC



IP67

3  
YEAR  
warranty



- **universal** use
- **the most economical** module
- **indoor / outdoor** use
- chain of **20 pcs**



## DIMENSIONS

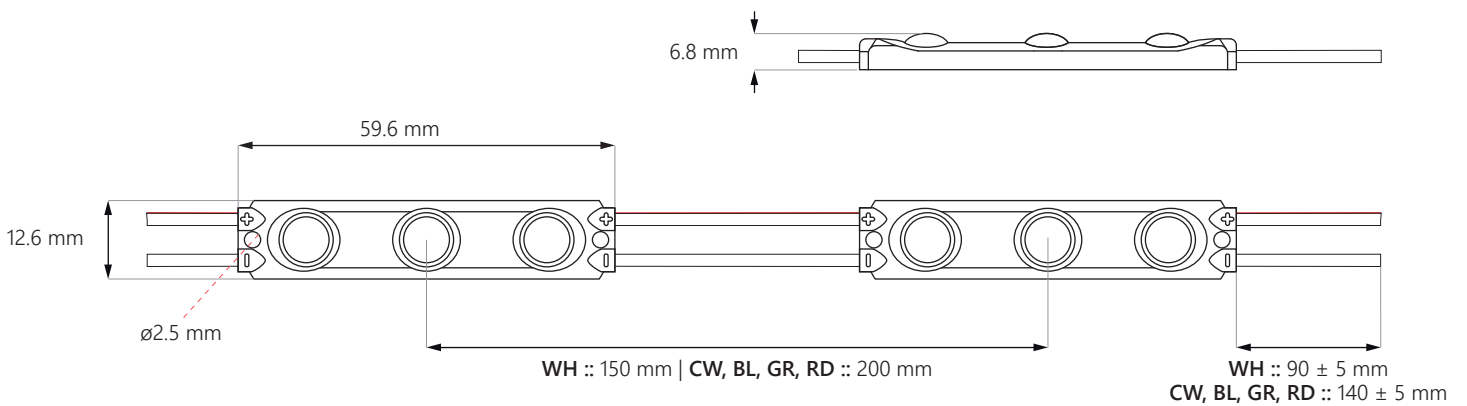



## CONNECTION DIAGRAM

one-side power input: **max 20 pcs**



two-side power input: **max 40 pcs**

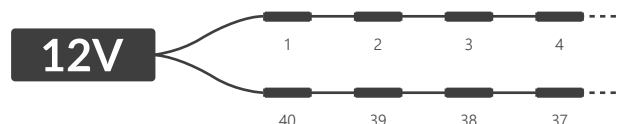

## TECHNICAL SPECIFICATION

Input voltage	12V DC
Nominal power usage per module	0.72 W
Nominal power usage per chain	14.4 W

Colour rendering index	≥82
Beam angle	160°
Current stabilization	NO
Dimmable	YES

Module dimensions (L x W x D)	59.6 x 12.6 x 6.8 mm
Cable length	WH :: 90 ± 5 mm   CW, BL, GR, RD :: 140 ± 5 mm
Module length including cable	WH :: 150 mm   CW, BL, GR, RD :: 200 mm
Chain length	WH :: 3 m   CW, BL, GR, RD :: 4 m
No. of modules in 1 m	WH :: 6,6 pcs   CW, BL, GR, RD :: 5 pcs

Lifespan	~50000 h
Working temperature	-25°C ÷ +55°C
IP Rating	IP67
Compliance with	CE / RoHS / WEEE
Warranty	3 years
Energy class	WH, CW :: E   BL, GR, RD :: G

## CCT / LIGHT COLOUR\*

Abbreviation	Light colour	Luminous Flux	CCT / Wavelength
WH	daily white	73 lm	~6500K
CW	cold white	77 lm	~10000K
BL	blue	11 lm	458-470 nm
GR	green	52 lm	518-525 nm
RD	red	22 lm	610-625 nm

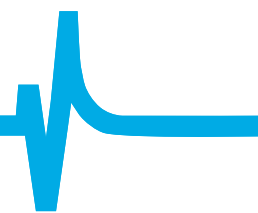

## APPLICATION

best for channel letters and lightboxes with a depth of **5-15 cm**

**7 cm**  
depth

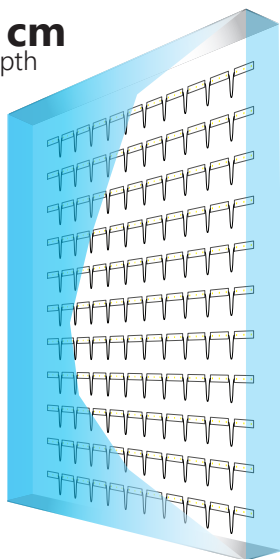

Area: **1 m<sup>2</sup>**  
CC distance: **9 cm**  
No. of modules: **121 pcs**  
Lumen output: **8833 lm**  
Power usage: **87.12 W**

**10 cm**  
depth

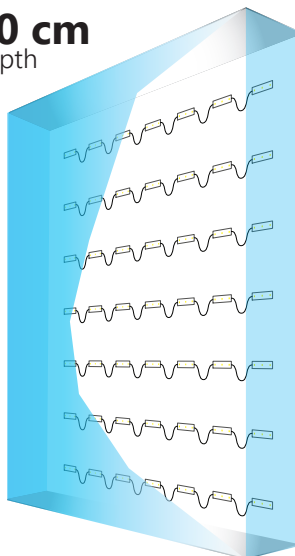

Area: **1 m<sup>2</sup>**  
CC distance: **14 cm**  
No. of modules: **49 pcs**  
Lumen output: **3577 lm**  
Power usage: **35.28 W**

**12 cm**  
depth

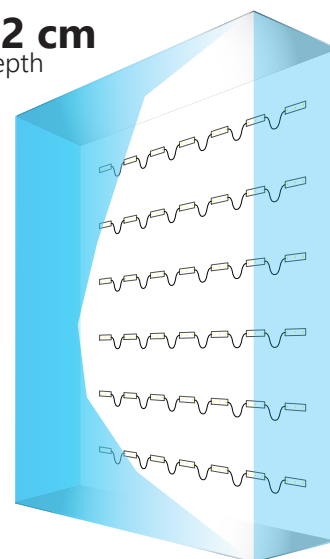

Area: **1 m<sup>2</sup>**  
CC distance: **15 cm**  
No. of modules: **42 pcs**  
Lumen output: **3066 lm**  
Power usage: **30.24 W**

**NOTE: the exact number of modules depends on the used materials and the effect we want to achieve.**  
Given data refers to white colour.

## PACKING INFORMATION

	Chain	Bag	Box
Quantity	20 pcs	100 pcs	2400 pcs
Gross weight	0.125 kg	0.625 kg	15 kg

## DOWNLOAD AREA

### LED Module installation guide

<https://www.epiled.pl/download/led-module-installation-guide.pdf>

### EU Declaration of Conformity

<https://www.epiled.pl/download/deklaracje/eu-declaration-of-conformity-led-modules.pdf>