

Planar Net 3W

3,5-10 cm
lighboxes / stretch ceilings

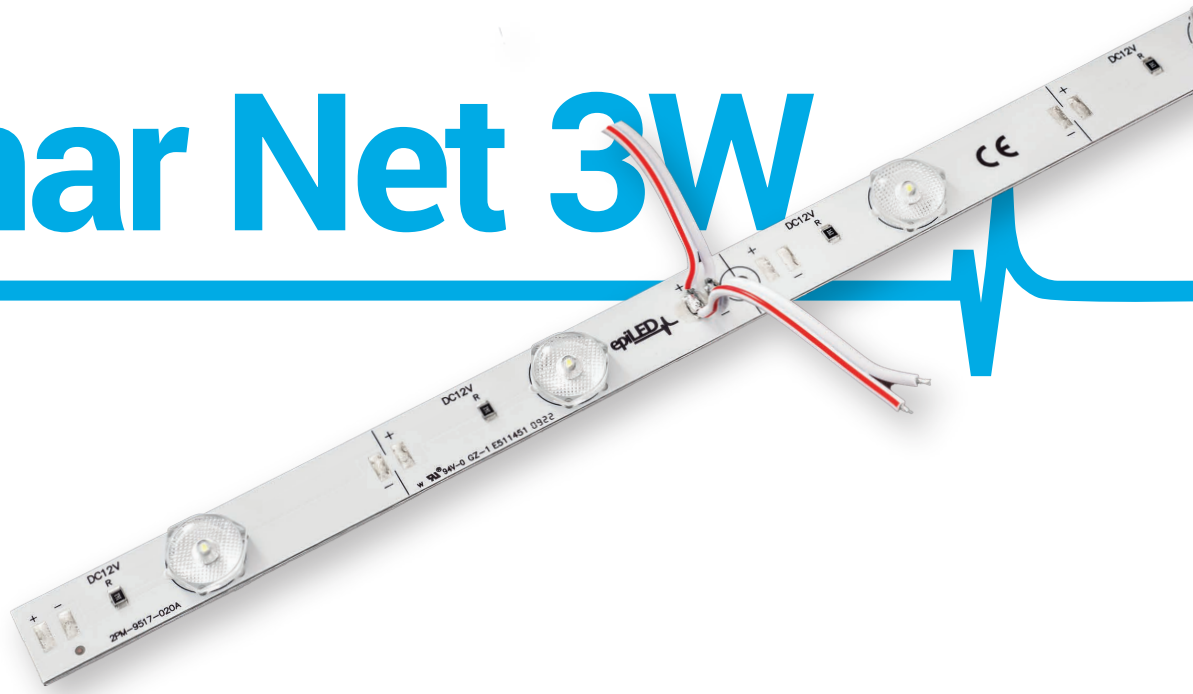
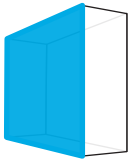

6.5W

12V
DC

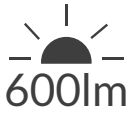

600lm

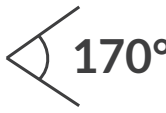

170°

IP₂₀

3
YEAR
warranty



PWM

- perfect **for slim applications**
- easy **installation**
- **indoor** use only
- chain of **10 pcs**



DIMENSIONS

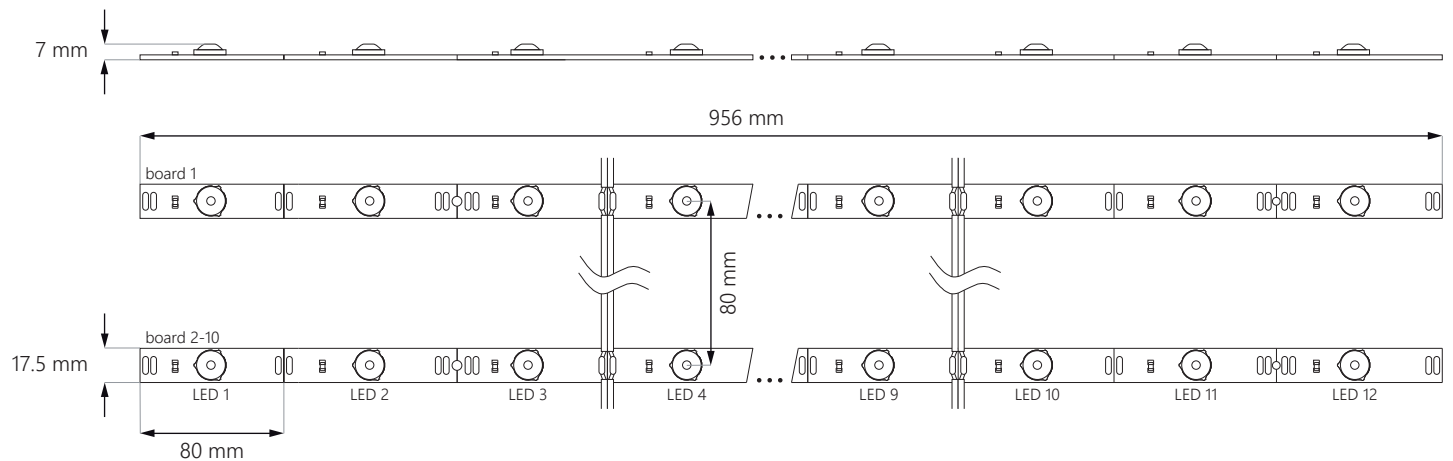

Planar Net 3W

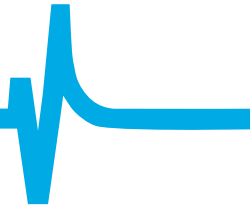

CHAIN

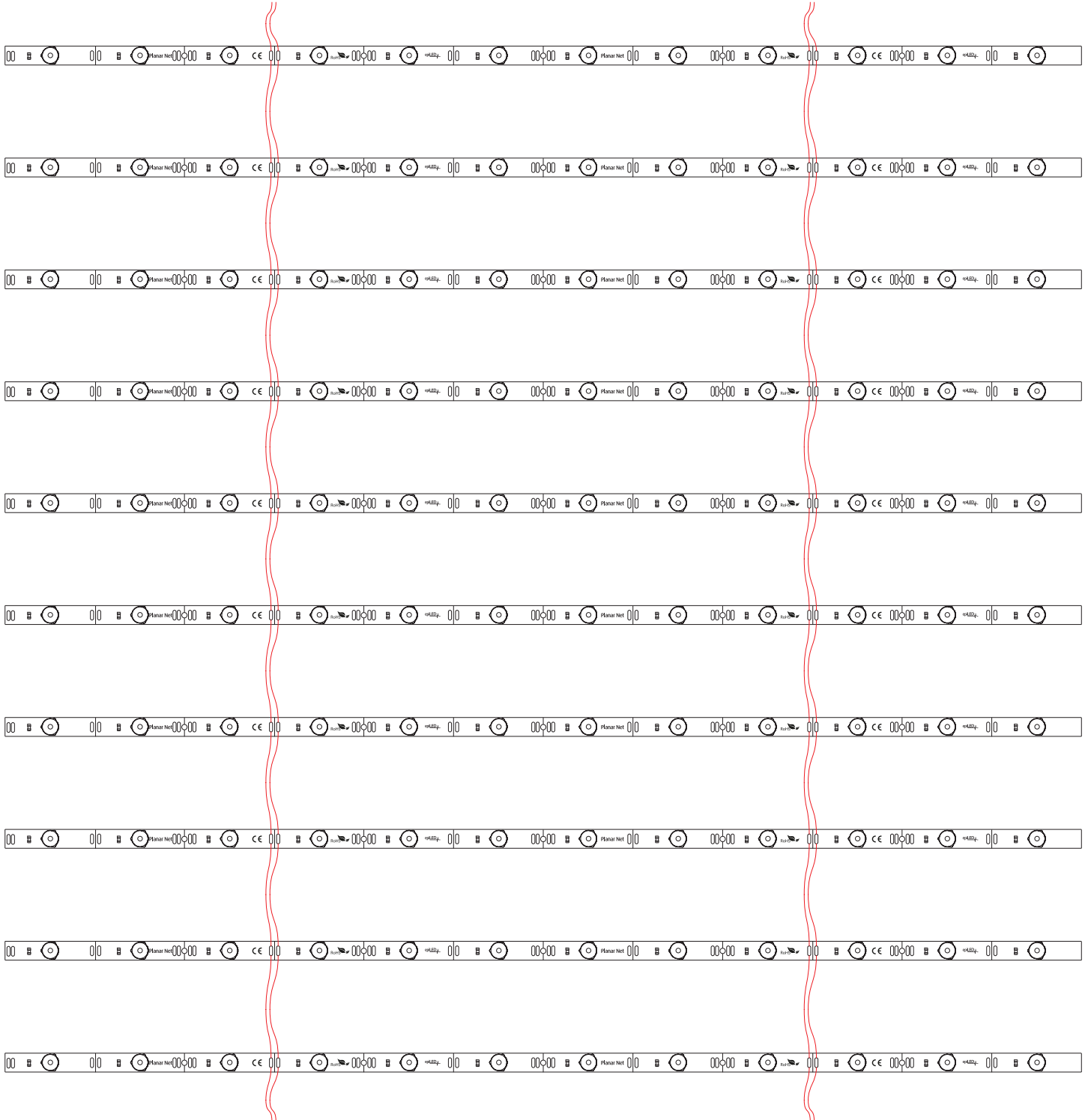

Planar Net 3W

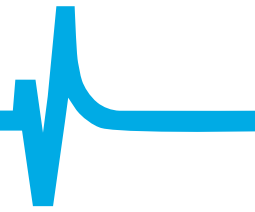

CONNECTION DIAGRAM

one-side power input: **max 10 pcs**

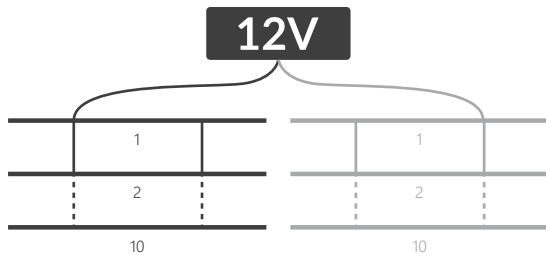

two-side power input: **max 20 pcs**

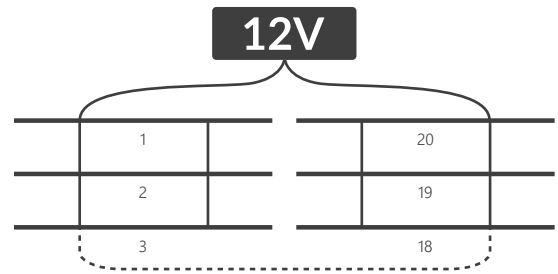

TECHNICAL SPECIFICATION

Input voltage	12V DC
Nominal power usage per module	6,5 W
Nominal power usage per chain	65 W
Colour rendering index	≥82
Beam angle	170°
Current stabilization	NO
Dimmable	YES
Module dimensions (L x W x D)	956 x 17.5 x 7 mm
Cable length	120 ± 5 mm
Module length including cable	-
Chain length	-
No. of modules in 1 m	1.05pcs
Lifespan	~50000 h
Working temperature	-25°C ÷ +55°C
IP Rating	IP20
Compliance with	CE / RoHS / WEEE / UL listed
Warranty	3 years

CCT / LIGHT COLOUR*

Abbreviation	Light colour	CCT
NW	neutral white	~4000K
WH	daily white	~6500K
CW	cold white	~10000K

* ask our sales team for details of available colours

Planar Net 3W

APPLICATION

best for channel letters and lightboxes with a depth of **3.5-10 cm**

4 cm
depth

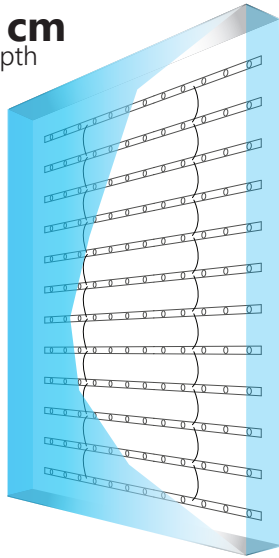

Powierzchnia: **1 m²**
Rozstaw: **8 cm**
Ilość modułów: **12 pcs**
Łączna jasność: **3120 lm**
Pobór mocy: **36 W**

8 cm
depth

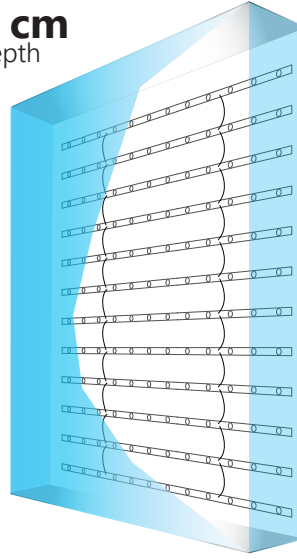

Powierzchnia: **1 m²**
Rozstaw: **8 cm**
Ilość modułów: **12 pcs**
Łączna jasność: **3120 lm**
Pobór mocy: **36 W**

NOTE: the exact number of modules depends on the used materials and the effect we want to achieve.

PACKING INFORMATION

	Chain	Bag	Box
Quantity	10 pcs	10 pcs	120 pcs
Gross weight	1.1 kg	1.1 kg	13.2 kg

DOWNLOAD AREA

LED Module installation guide

<https://www.epiled.pl/download/led-module-installation-guide.pdf>

EU Declaration of Conformity

<https://www.epiled.pl/download/deklaracje/eu-declaration-of-conformity-led-modules.pdf>

© 2022, epiLED. All rights reserved. Data is subject to change without notice. | Rev.: 2206

ul. Stanisławowska 27, 54-611 Wrocław • Poland • info@epiLED.pl • www.epiLED.pl