

Opticor²

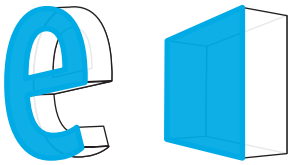

8-17 cm
channel letters / lightboxes



12V
DC

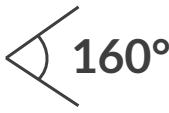
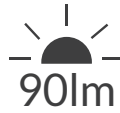

IP67

5
YEAR
warranty

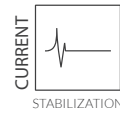

- perfect for **day & night letters**
- constant current **stabilization**
- **indoor / outdoor** use
- chain of **40 pcs**



DIMENSIONS

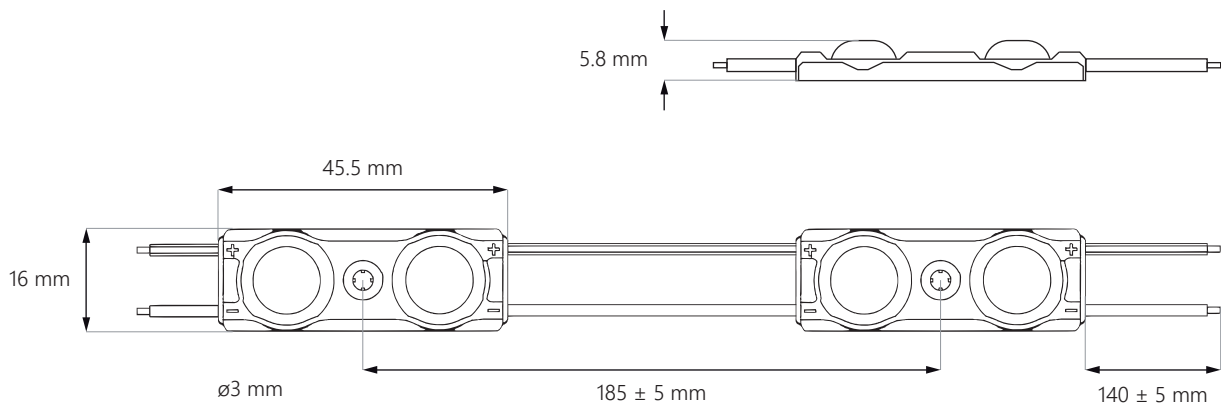

Opticor²

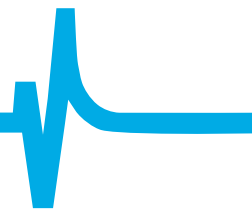

CONNECTION DIAGRAM

one-side power input: **max 40 pcs**



two-side power input: **max 80 pcs**

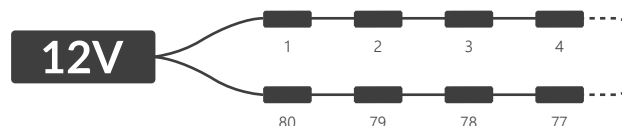

TECHNICAL SPECIFICATION

Input voltage	12V DC
Nominal power usage per module	0.96 W*
Nominal power usage per chain	38.4 W*

Colour rendering index	≥82
Beam angle	160°
Current stabilization	YES
Dimmable	YES

Module dimensions (L x W x D)	45.5 x 16 x 5.8 mm
Cable length	140 ± 5 mm
Module length including cable	185 mm
Chain length	7.4 m
No. of modules in 1 m	5.4 pcs

Lifespan	~50000 h
Working temperature	-40°C ÷ +60°C
IP Rating	IP67
Compliance with	CE / RoHS / WEEE / UL listed
Warranty	5 years

* given data refers to white colour

CCT / LIGHT COLOUR*

Abbreviation	Light colour	CCT
WW	warm white	~3000K
NW	neutral white	~4000K
WH	daily white	~6500K
CW	cold white	~10000K
BL	blue	460-470 nm
GR	green	520-530 nm
YL	yellow	575-585 nm
RD	red	620-630 nm

* ask our sales team for details of available colours

Opticor²

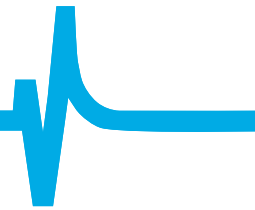

APPLICATION

best for channel letters and lightboxes with a depth of **8-17 cm**

8 cm
depth

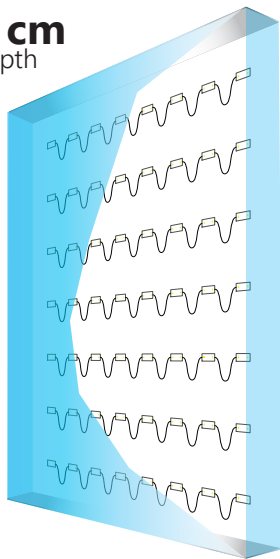

Area: **1 m²**
CC distance: **13 cm**
No. of modules: **56 pcs**
Lumen output: **5040 lm**
Power usage: **53.76 W**

10 cm
depth

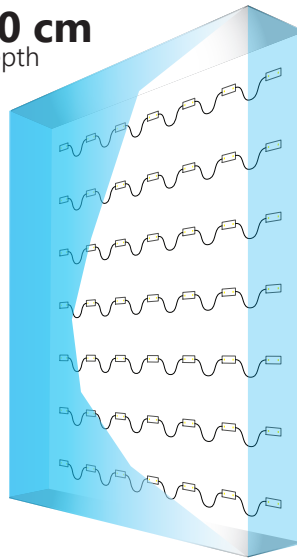

Area: **1 m²**
CC distance: **15 cm**
No. of modules: **49 pcs**
Lumen output: **4410 lm**
Power usage: **47.04 W**

15 cm
depth

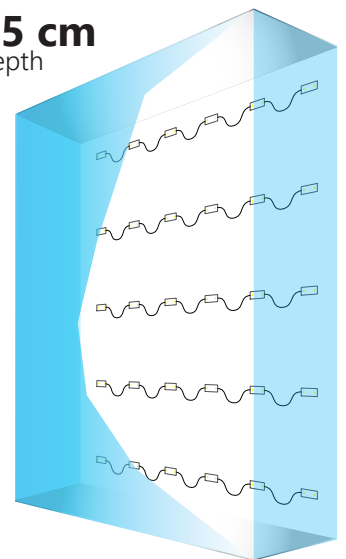

Area: **1 m²**
CC distance: **18,5 cm**
No. of modules: **30 pcs**
Lumen output: **2700 lm**
Power usage: **28.8 W**

**NOTE: the exact number of modules depends on the used materials and the effect we want to achieve.
Given data refers to white colour.**

PACKING INFORMATION

	Chain	Bag	Box
Quantity	40 pcs	20 pcs	2400 pcs
Gross weight	0.3 kg	1.5 kg	18 kg

DOWNLOAD AREA

LED Module installation guide

<https://www.epiled.pl/download/led-module-installation-guide.pdf>

EU Declaration of Conformity

<https://www.epiled.pl/download/deklaracje/eu-declaration-of-conformity-led-modules.pdf>

© 2024, epiLED. All rights reserved. Data is subject to change without notice. | Rev.: 2406

ul. Stanisławowska 27, 54-611 Wrocław • Poland • info@epiLED.pl • www.epiLED.pl