

Opticor¹

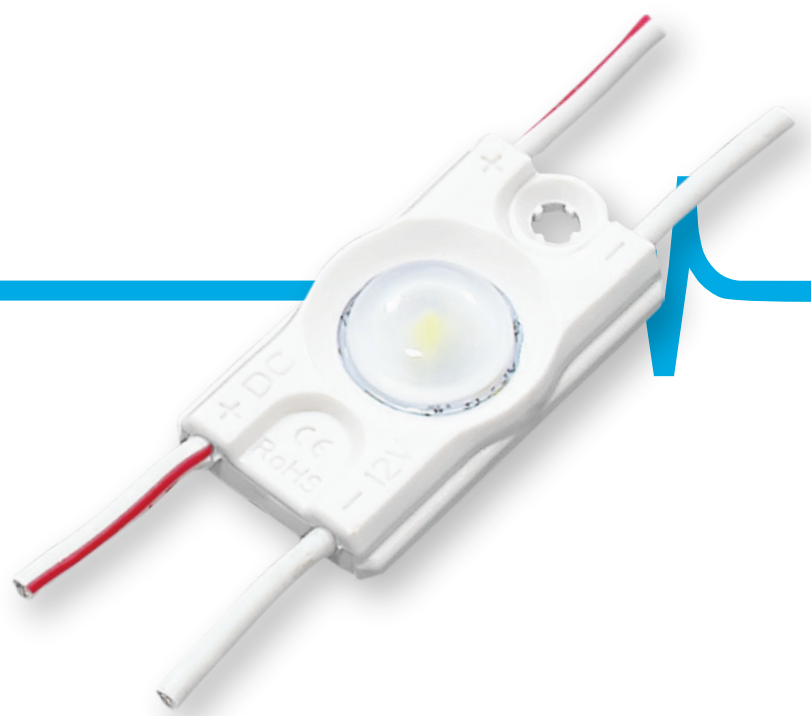

5-10 cm
channel letters / lightboxes

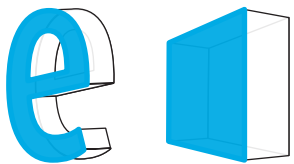

12V
DC

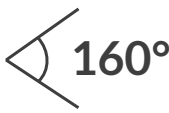

IP67

5
YEAR
warranty

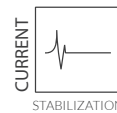

- perfect for **day & night letters**
- constant current **stabilization**
- **indoor / outdoor** use
- chain of **50 pcs**



DIMENSIONS

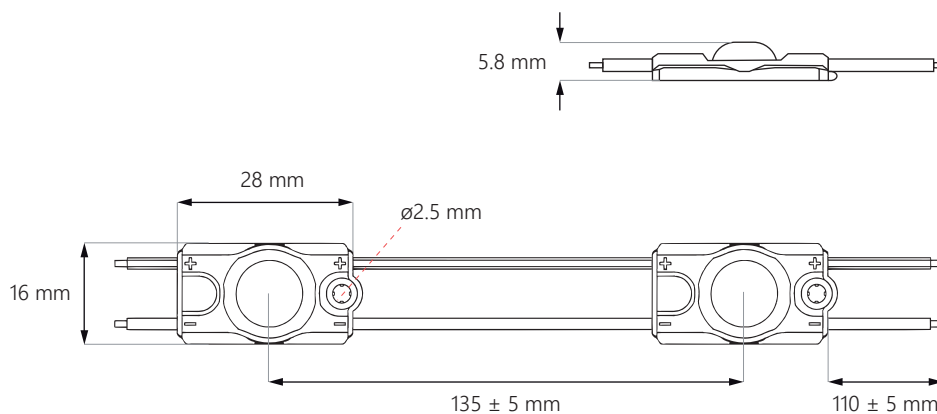

Opticor¹

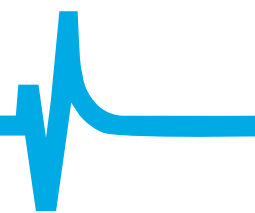

CONNECTION DIAGRAM

one-side power input: **max 50 pcs**

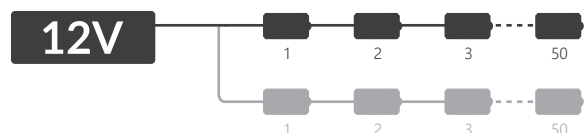

two-side power input: **max 100 pcs**

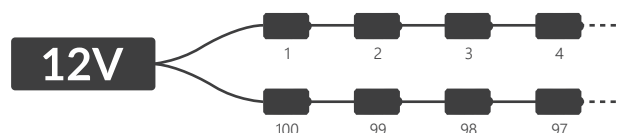

TECHNICAL SPECIFICATION

Input voltage	12V DC
Nominal power usage per module	0.48 W*
Nominal power usage per chain	24 W*
Colour rendering index	≥82
Beam angle	160°
Current stabilization	YES
Dimmable	YES
Module dimensions (L x W x D)	28 x 16 x 5.8 mm
Cable length	110 ± 5 mm
Module length including cable	138 mm
Chain length	6,9 m
No. of modules in 1 m	7.25 pcs
Lifespan	~50000 h
Working temperature	-40°C ÷ +60°C
IP Rating	IP67
Compliance with	CE / RoHS / WEEE / UL listed
Warranty	5 years

* given data refers to white colour

CCT / LIGHT COLOUR*

Abbreviation	Light colour	CCT
WW	warm white	~3000K
NW	neutral white	~4000K
WH	daily white	~6500K
CW	cold white	~10000K
BL	blue	460-470 nm
GR	green	520-530 nm
YL	yellow	575-585 nm
RD	red	620-630 nm

* ask our sales team for details of available colours

Opticor¹

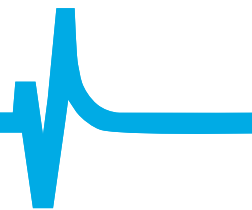

APPLICATION

best for channel letters and lightboxes with a depth of **5-10 cm**

5 cm
depth

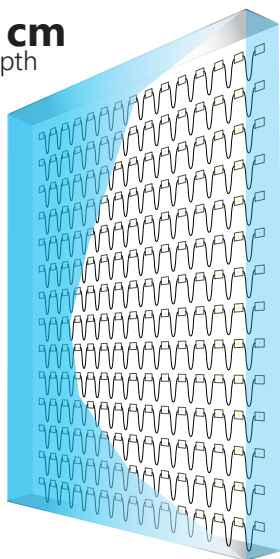

Area: **1 m²**
CC distance: **7 cm**
No. of modules: **210 pcs**
Lumen output: **9450 lm**
Power usage: **100.8 W**

8 cm
depth

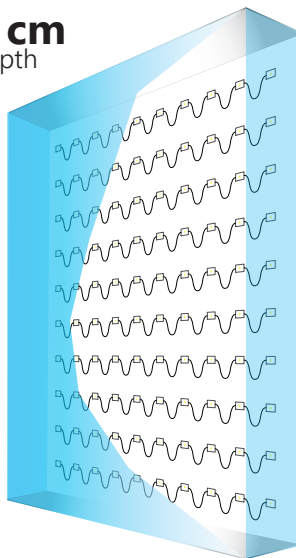

Area: **1 m²**
CC distance: **10 cm**
No. of modules: **100 pcs**
Lumen output: **4500 lm**
Power usage: **48 W**

10 cm
depth

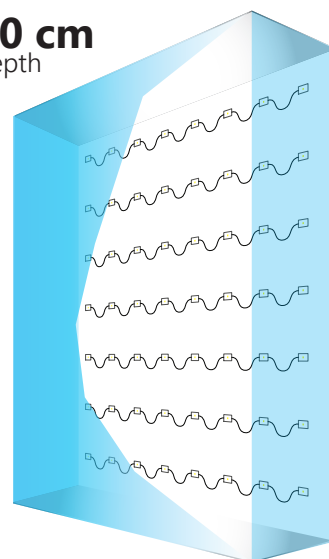

Area: **1 m²**
CC distance: **13,5 cm**
No. of modules: **56 pcs**
Lumen output: **2520 lm**
Power usage: **26.88 W**

NOTE: the exact number of modules depends on the used materials and the effect we want to achieve.
Given data refers to white colour.

PACKING INFORMATION

	Chain	Bag	Box
Quantity	50 pcs	300 pcs	4200 pcs
Gross weight	0.24 kg	1.44 kg	20.16 kg

DOWNLOAD AREA

LED Module installation guide

<https://www.epiled.pl/download/led-module-installation-guide.pdf>

EU Declaration of Conformity

<https://www.epiled.pl/download/deklaracje/eu-declaration-of-conformity-led-modules.pdf>

© 2024, epiLED. All rights reserved. Data is subject to change without notice. | Rev.: 2406

ul. Stanisławowska 27, 54-611 Wrocław • Poland • info@epiLED.pl • www.epiLED.pl