

Luno 1.08W

6-15 cm
channel letters / lightboxes

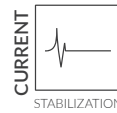

- constant current **stabilization**
- **universal** use
- **indoor / outdoor** use
- chain of **30 pcs**

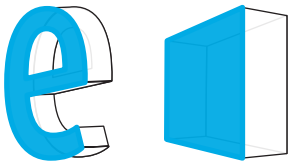

DIMENSIONS

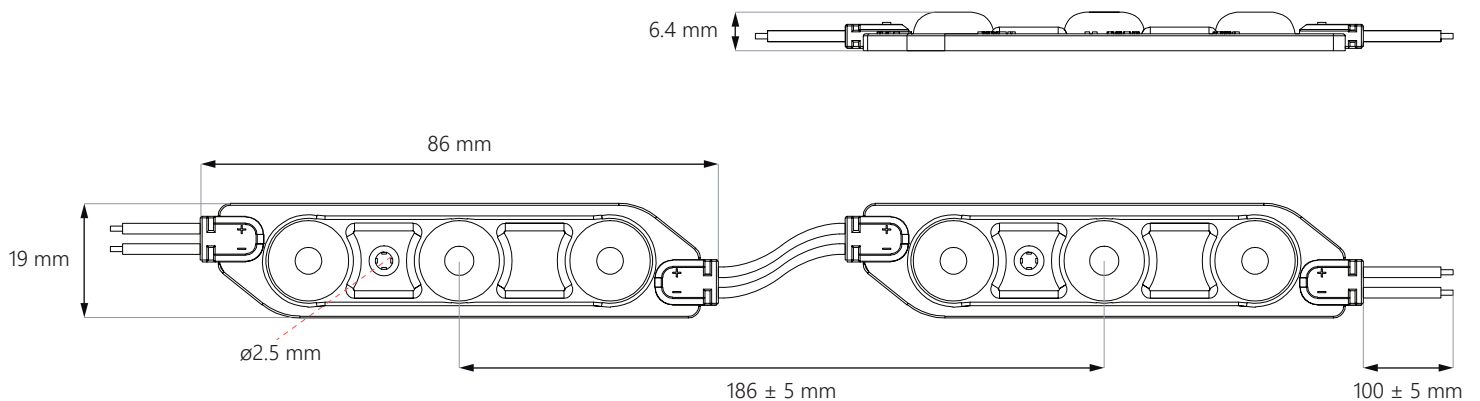

Luno 1.08W

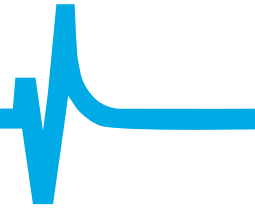

CONNECTION DIAGRAM

one-side power input: **max 30 pcs**

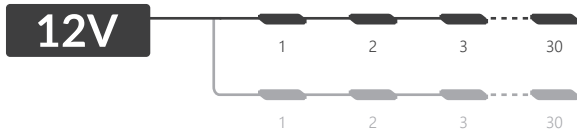

two-side power input: **max 60 pcs**

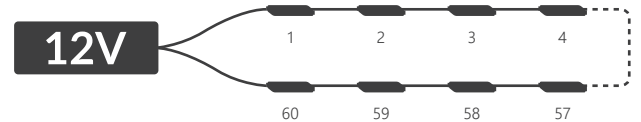

TECHNICAL SPECIFICATION

Input voltage	12V DC
Nominal power usage per module	1.08 W
Nominal power usage per chain	32.4 W
Colour rendering index	≥82
Beam angle	165°
Current stabilization	YES
Dimmable	YES
Module dimensions (L x W x D)	86 x 19 x 6.4 mm
Cable length	100 ± 5 mm
Module length including cable	186 mm
Chain length	5.58 m
No. of modules in 1 m	5.38 pcs
Lifespan	~50000 h
Working temperature	-20°C ÷ +50°C
IP Rating	IP67
Compliance with	CE / RoHS / WEEE / UL listed
Warranty	5 years

CCT / LIGHT COLOUR*

Abbreviation	Light colour	CCT
WB	white	~8700K

* ask our sales team for details of available colours

Luno 1.08W



APPLICATION

best for channel letters and lightboxes with a depth of **6-15 cm**

7 cm
depth

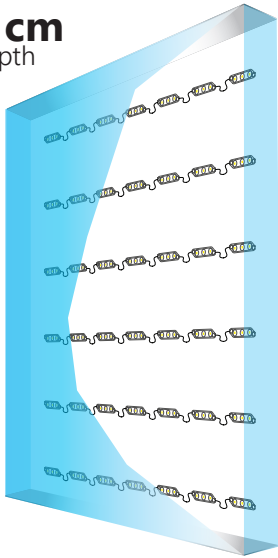

Area: **1 m²**
CC distance: **15 cm**
No. of modules: **42 pcs**
Lumen output: **5250 lm**
Power usage: **45.36 W**

10 cm
depth

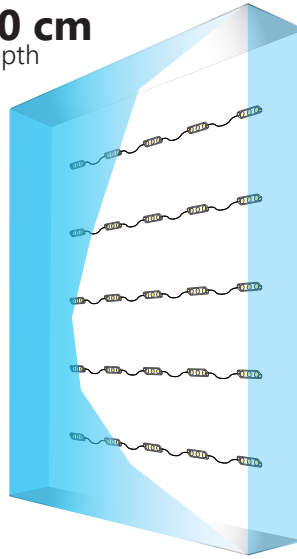

Area: **1 m²**
CC distance: **18.6 cm**
No. of modules: **25 pcs**
Lumen output: **3125 lm**
Power usage: **27 W**

15 cm
depth

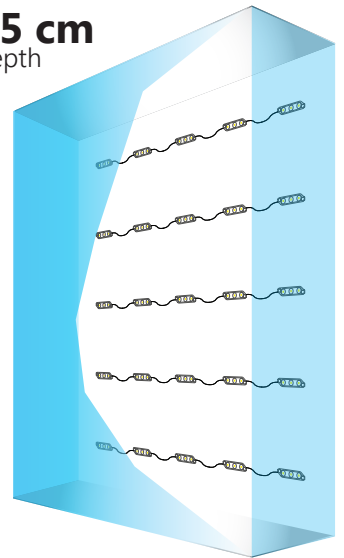

Area: **1 m²**
CC distance: **18.6 cm**
No. of modules: **25 pcs**
Lumen output: **3125 lm**
Power usage: **27 W**

NOTE: the exact number of modules depends on the used materials and the effect we want to achieve.

PACKING INFORMATION

	Chain	Bag	Box
Quantity	30 pcs	120 pcs	1440 pcs
Gross weight	0.38 kg	1.54 kg	18.43 kg

DOWNLOAD AREA

LED Module installation guide

<https://www.epiled.pl/download/led-module-installation-guide.pdf>

EU Declaration of Conformity

<https://www.epiled.pl/download/deklaracje/eu-declaration-of-conformity-led-modules.pdf>

© 2021, epiLED. All rights reserved. Data is subject to change without notice. | Rev.: 2108

ul. Stanisławowska 27, 54-611 Wrocław • Poland • info@epiLED.pl • www.epiLED.pl